

ULTRASONIC TESTER

UK1401

OPERATION MANUAL



Acoustic Control Systems – Solutions GmbH
Saarbrücken 2018



CONTENTS

| | |
|---|-----------|
| 1 DESCRIPTION AND OPERATION OF THE INSTRUMENT..... | 6 |
| 1.1 THE INTENDED USE OF THE INSTRUMENT..... | 6 |
| 1.1.1 Intended Use and Application Range..... | 6 |
| 1.1.2 Operating Conditions..... | 6 |
| 1.2 TECHNICAL SPECIFICATIONS..... | 7 |
| 1.3 INSTRUMENT DESIGN AND OPERATION PRINCIPLE..... | 8 |
| 1.3.1 Design..... | 8 |
| 1.3.2 OPERATION PRINCIPLE..... | 10 |
| 1.3.3 OPERATION MODES..... | 10 |
| 1.3.4 SCREEN OF THE INSTRUMENT..... | 11 |
| 1.3.5 Keyboard..... | 15 |
| 2 PROPER USE OF THE INSTRUMENT..... | 16 |
| 2.1 OPERATING RESTRICTIONS..... | 16 |
| 2.2 MAKING INSTRUMENT READY FOR OPERATION..... | 16 |
| 2.2.1 Preparation of the Surface..... | 16 |
| 2.2.2 Switch On/Off the Instrument..... | 16 |
| 2.2.3 Functional Check..... | 16 |
| 2.3 WORKING WITH THE INSTRUMENT..... | 18 |
| 2.3.1 SETUP mode..... | 18 |



| | |
|-----------------------------------|-----------|
| 2.3.2 TIME / VELOCITY Modes | 31 |
| 2.3.3 CRACK mode..... | 34 |
| 2.3.4 FRONT mode | 35 |
| 2.4 TRANSFER DATA TO PC..... | 36 |
| 3 MAINTENANCE..... | 38 |
| 3.1 ACCUMULATOR..... | 38 |
| 3.2 CHARGING THE ACCUMULATOR..... | 38 |
| 3.3 TROUBLESHOOTING | 38 |
| 4 STORAGE | 39 |
| 5 Transportation..... | 40 |

The present operation manual (hereinafter referred to as “the manual”) includes information on the technical specifications, description of the design and operation principle, as well as well as information on proper use of the UK1401 Ultrasonic Testers (hereinafter referred to as “the testers” or the “instruments”).

Carefully study this Operation Manual prior to working with the instrument.

The “ACS” company continuously upgrades the quality and functions, improves the safety and serviceability of its instruments, hence during the production of the instruments some minor modifications can be introduced to them that don't affect the technical specifications, and thus they may be omitted in current version of the operation manual.

The instrument is manufactured by:

ACS-Solutions GmbH
Science Park 2
66123 Saarbrücken, Germany

Phone: +49 (0) 681-96592270
Fax: +49 (0) 681-96592280
E-mail: info@acs-international.com
Website: www.acs-international.com

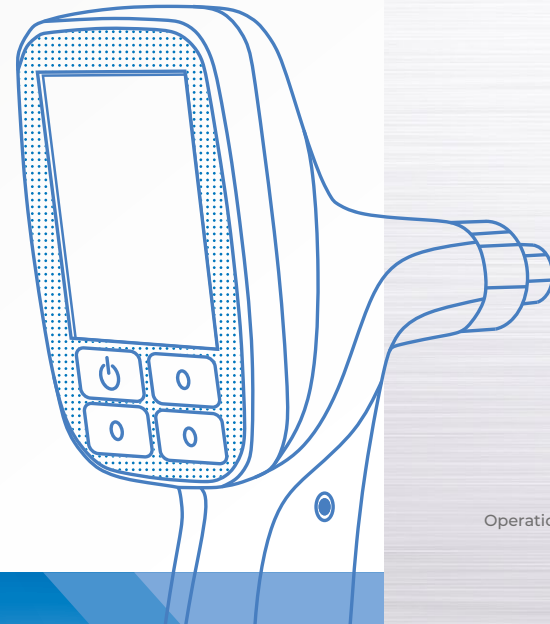



1

DESCRIPTION AND OPERATION OF THE INSTRUMENT

1.1 THE INTENDED USE OF THE INSTRUMENT

1.1.1 Intended Use and Application Range

UK1401 Ultrasonic Testers are designed for measurements of time and propagation velocity of longitudinal ultrasonic waves in solid materials when doing surface scanning on a rigid foundation in order to determine the strength and soundness of materials and facilities.

The main application areas of the instruments:

- determination of concrete strength by the ultrasonic sound velocity according to GOST 17624 87;
- determination of concrete strength of the structures being in service along with the "separation with chopping off" procedure;
- evaluation of the load carrying capacity of concrete supports and pillars made of centrifugally cast concrete based on the relation of the ultrasonic sound propagation velocities in the directions along and across of the support axis.

Additional features:

- searching for near-surface defects in concrete structures by abnormal velocity decrease or increase of ultrasound propagation time in the defective (unsound) spot/areas as compared to the areas without defects;
- evaluation of the depth of the cracks facing the concrete or stone surface;
- evaluation of the porosity and cracked structure of subsurface rock, anisotropy degree and structure of composite materials;
- evaluation of the similarity or difference of elastic properties of the materials or samples of the same material as compared to each other, as well as material age provided their properties change over a period of time.

Technical solutions used to produce the instruments, are protected by the Russian Federation Patent No. 2082163.

1.1.2 Operating Conditions

The instruments are designed for operation under the following conditions:

- ambient air temperature: from -20 to $+50$ °C;
- relative air humidity up to 95 % at $+35$ °C.

1.2 TECHNICAL SPECIFICATIONS

The main technical specifications of the device are listed in the Table 1

Table 1

| Parameter name | Value |
|---|---|
| Delay adjustment range, μs | from 2 to 20 |
| Operational frequency, kHz | 50 |
| Measurement base, mm | 150 ± 1 |
| Indication discreteness of propagation time of ultrasonic waves, μs | 0.1 |
| Indication discreteness propagation velocity of ultrasonic waves, m/s | 10 |
| Measurement range of propagation time of longitudinal ultrasonic waves, μs | from 12.5 to 150.0 |
| Measurement range of propagation velocity of longitudinal ultrasonic waves, m/s | from 1 000 to 12 000 |
| Limits of permissible absolute measurement error of propagation time of ultrasonic waves, μs , where t – measured time value | $\pm(0.01 \cdot t + 0.1)$ |
| Limits of permissible absolute measurement error of propagation velocity of ultrasonic waves, m/s, where c – measured velocity value | $\pm(0.012 \cdot c + K \cdot c^2 + 10)$, where $K = 6,7 \cdot 10^{-9} \text{ (m/s)}^{-1}$ |
| Nominal voltage, V | 3.3 |
| Period of continuous operation of the instrument with 80% value of screen brightness, at 25 °C, working with 6 Hz measurement frequency, min. | 16 hours |
| Overall dimensions of the instrument, mm, max. | 235x155x65 |
| Maximum weight of the instrument, max. | 450 g |
| Average time between failures | 18,000 hours |
| Average service life | 5 |

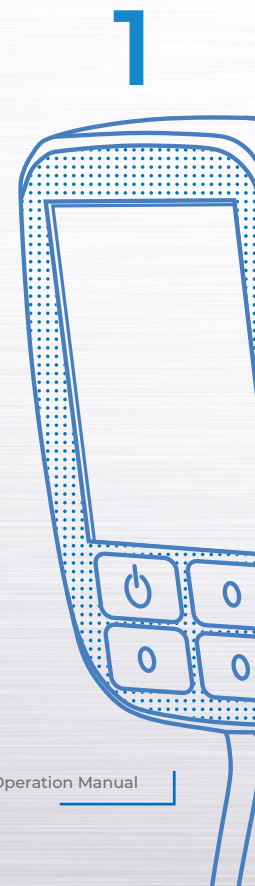

1.3 INSTRUMENT DESIGN AND OPERATION PRINCIPLE

1.3.1 Design

The instrument represents an electronic unit (Figure 1) enclosed into a plastic case in which two spring-driven ultrasonic transducers (transmitting and receiving) are rigidly mounted.



Figure 1

Ultrasonic transducers have cone-type protectors. The ceramic wear proof nozzles are fixed on tops of the protectors.

Due to almost spot acoustic contact of the transducers with surface of the inspected material, there is no need for coupling fluid to establish acoustic coupling with the inspected object.

The upper part of the face panel of the electronic unit bears a color TFT screen. The screen displays measurement results and service information required to control the instrument. The instrument's screen ensures full visual monitoring of the inspection process with the help of color indication.

A membrane keyboard enabling control over the instrument is located under the screen.

The opposite side of the case bears the ENTER button (Figure 2).

The lower end face panel of the electronic unit bears the fastener for the belt and an USB Micro B connector used for connection to a PC via the USB cable and charging of the built-in accumulator by means of the AC adapter 220 V – USB (Figure 3).

1



Figure 2

Enter
button



Figure 3

Fastener for
the belt

USB Micro B
connector

1



1.3.2 Operation principle

The instrument measures the time interval during which the ultrasonic pulse goes through the inspected object from the transmitting transducer to the receiving transducer. The ultrasonic sound velocity is determined by dividing the distance value between the points of emission and receiving points of ultrasonic waves, by the measured time value. The ultrasonic pulse emission and reception are periodically repeated to increase the measurement reliability. The final value obtained after processing of the sequence of several received ultrasonic signals is displayed on the screen.

Ultrasonic pulses go through the inspected object close to its surface in the form of elastic waves of various types. The instrument counts the measured time interval according to the earliest impulse coming to the receiving transducer. Therefore, the instrument measures velocity of the acoustic waves propagating through the given material with the highest velocity.

Primary energy of ultrasonic pulses propagates in the near-surface 2-3 cm thick layer of the material. If there is some kind of imperfection of material (cavity or crack close to surface) in the way of the wave, then the wave will bypass it and will arrive to the receiver in the weakened state or with delay as compared to the place without structural imperfection. In that case, the lower velocity of sound or longer propagation time of the ultrasonic wave as compared to other spots (areas) are a sign of a defect in the material structure invisible from the surface.

If the crack faces the surface, then it will completely block the path of the ultrasonic wave along the surface. In that case, only a small part of the wave energy can bypass the crack within the material (up to 50 mm in the depth) and return to the receiving transducer. Due to longer path, its propagation time will exceed the propagation time of the wave going the shortest path (without a crack) between the transducers. The measurement process of the crack depth is based on comparison of these time intervals.

1.3.3 Operation modes

The instrument can be operated in the following modes:

- TIME – measurement of propagation time of ultrasonic waves in the material;
- VELOCITY – measurement of propagation velocity of ultrasonic waves in the material;
- CRACK – evaluation of the depth of the crack facing the surface;

- FRONT – measurement of the time interval from the moment the when the signal exceeds the threshold level for the first time (the threshold value is set automatically according to the noise peaks) to the moment when the first half wave of the signal will reach its maximum;
- SETUP – adjustment and selection of the measurement parameters.

1.3.4 Screen of the instrument

The upper line displayed on the screen indicates the information on the current operation mode and battery charge level in all operation modes. The icons of the operation modes are given in the Table 2.

Table 2

| Tab | Operation mode |
|-----|----------------|
| | TIME |
| | VELOCITY |
| | CRACK |
| | FRONT |
| | SETUP |

The icons of the measurement modes are always arranged from left to right as follows: TIME/VELOCITY – CRACK – FRONT. The active mode is highlighted in yellow (Figure 4).

After the user entered the SETUP mode, its icon will replace the icon of the previous mode, the parameters and settings of the mode become configurable (Figure 5).

Figure 4





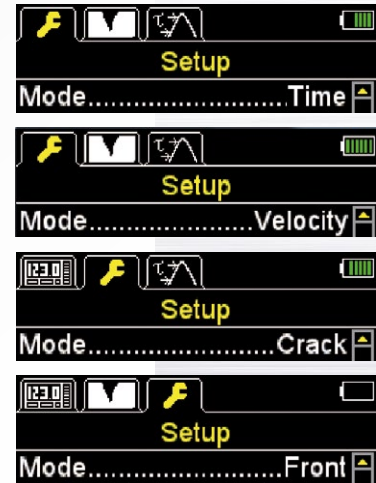

Figure 5



The icons informing on the presence and strength of the signal, measurement units and numeric value of the measurement result are constantly displayed in all modes.

Table 3 contains description of the acoustic contact indicators.

Table 3

| Type of the indicator | Description |
|---|---|
|  | Very high signal level. The AGC should be switched off |
|  | Maximum signal level. The amplification of the receive path is set to minimum value |
|  | Average signal level. The amplification of the receive path is set to the average value |
|  | Minimum signal level. The amplification of the receive path is set to the maximum value |
|  | There is no signal or the signal is too weak for measurements |

Display of the instrument in the TIME mode is shown in the Figure 6.
 Display of the instrument in the VELOCITY mode is shown in the Figure 7.

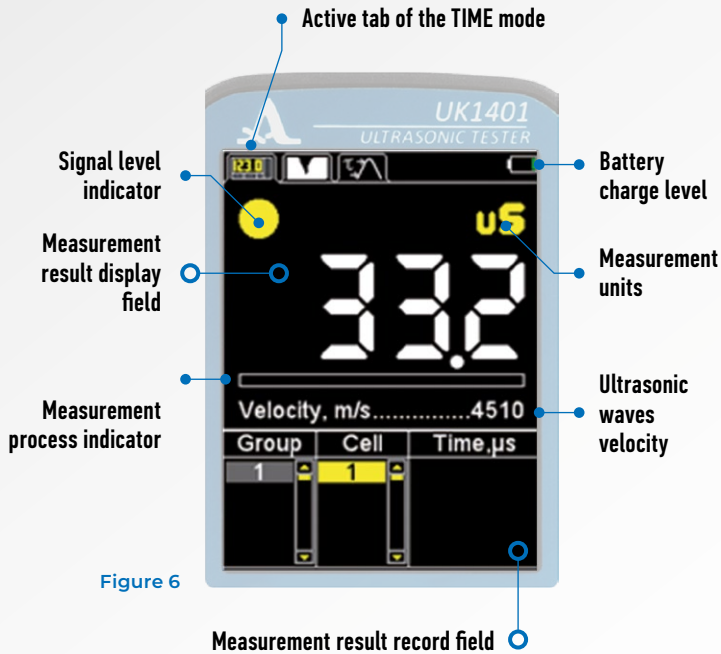

Figure 6

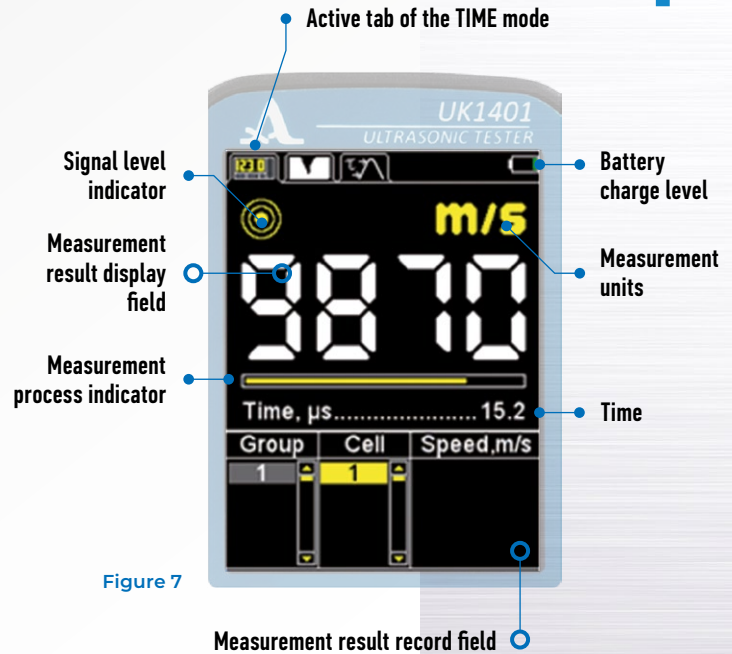
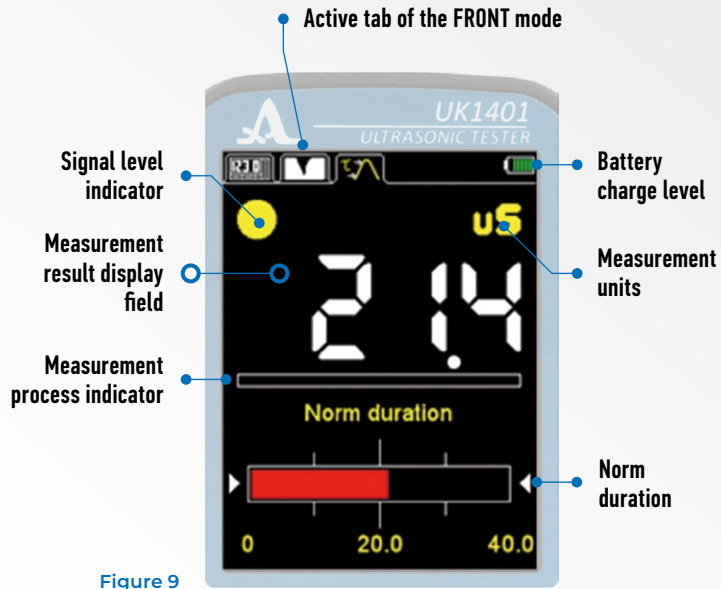
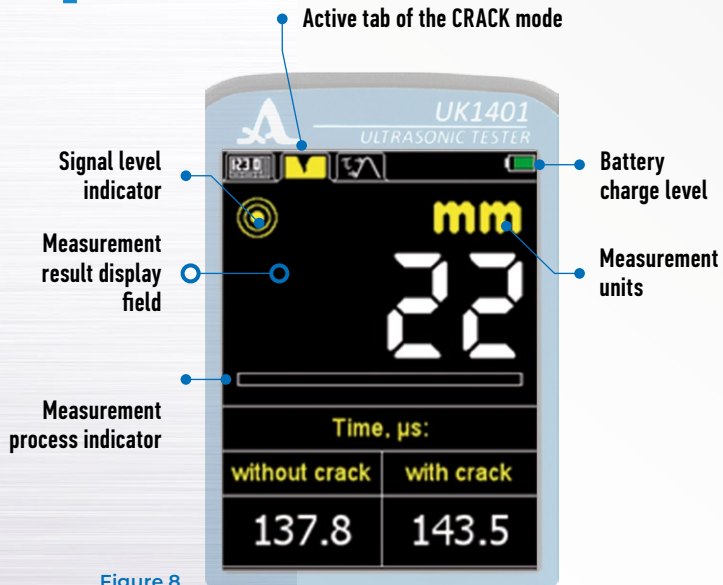

Figure 7

Display of the instrument in the CRACK mode is shown in the Figure 8.
Display of the instrument in the FRONT mode is shown in the Figure 9.

1





1.3.5 Keyboard

There are three functional keys and the On/Off key on the keyboard (Figure 10).

Main key functions:

- The key  (ON / OFF) is used to switch On/Off the instrument.

ATTENTION: THE INSTRUMENT WILL AUTOMATICALLY SWITCH OFF AFTER 10 MINUTES IN THE STANDBY MODE (NO KEY IS PRESSED, NO MEASUREMENT IS PERFORMED). AFTER 2 MINUTES THE DISPLAY BRIGHTNESS WILL AUTOMATICALLY BE SET TO THE MINIMAL LEVEL, IF NO KEY IS PRESSED DURING THIS TIME OR NO MEASUREMENT IS PERFORMED!

- The  key is used to switch from the measurement modes to the SETUP mode and vice versa.
- The  /  keys are used to select and configure the active parameters. Their functions are common for different operation modes. The keys are user-friendly since their icons indicate their functions.

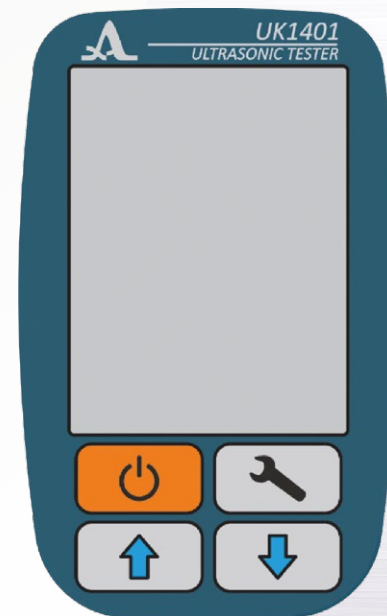

Figure 10



2

PROPER USE OF THE INSTRUMENT

2.1 OPERATING RESTRICTIONS

The instrument is designed to be operated under conditions listed in Section 1.1.2.

2.2 MAKING INSTRUMENT READY FOR OPERATION

2.2.1 Preparation of the Surface

The surface of the inspected object must be cleaned of dirt and sand.

2.2.2 Switch On/Off the Instrument

Press the  key to switch On the instrument.

A start-up window is displayed on the screen, including the name and the firm-ware version of the instrument (Figure 11).

The instrument will automatically enter the last active mode, all the corresponding settings are saved.

Press the  key to switch off the instrument or wait 10 minutes without pressing any key or performing measurements for the instrument to switch Off automatically.

All the adjustments are saved when the thickness gauge is switched off or its battery is dead.

2.2.3 Functional Check

Use a reference Plexiglas sample included in the delivery kit for instrument functional check. The sample bears a time value that a properly operating instrument should indicate at 20°C.

Functional check procedure:

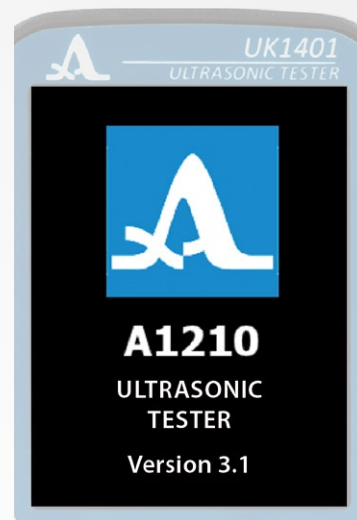

Figure 11

2

- Switch On the instrument.
- Select TIME as an observed value.
- Place the instrument on the reference sample as indicated in the Figure 12.
- Apply pressure on the instrument and fix it.
- Wait for 15 20 seconds for the readings to become stable.
- Read and record at least 5 measurement readings.
- Remove the instrument from the sample.
- Calculate average time value according to the received data.
- Measure actual temperature of the reference sample.
- Find the difference between the 20°C and actual temperatures.
- If actual temperature is different from 20°C, then subtract the temperature difference value, multiplied by 0.07 μ s, from the calculated average time value.
- Compare the result with the time values specified on the sample.

NOTE: THE INSTRUMENT READINGS MUST NOT DIFFER FROM THE TIME VALUE SPECIFIED ON THE REFERENCE SAMPLE BY MORE THAN 2 μ S EITHER WAY! IF THEY DIFFER BY MORE THAN 2 μ S, CONTACT THE MANUFACTURER.



Figure 12

2

2.3 WORKING WITH THE INSTRUMENT

2.3.1 SETUP mode

The SETUP mode includes the following options: list of the configurable parameters and calibration procedures.

All the adjustments will be saved when the instrument is switched Off, or its battery is dead.

The screen of the instrument in the SETUP mode is shown in the Figure 13.

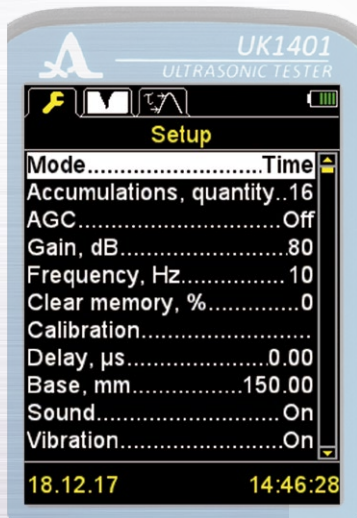

Figure 13

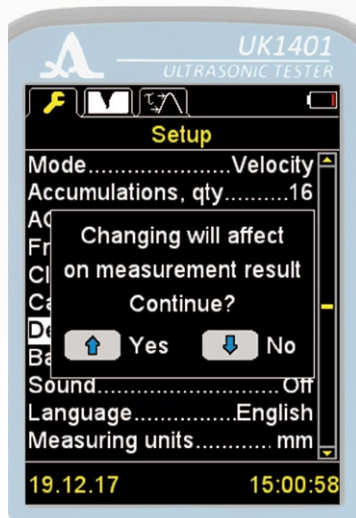

Figure 14

The   keys:

- navigation of the active line along the menu options, the navigation is performed cyclically in both directions. The parameter highlighted in the active line becomes selectable or editable;
- edit the parameter value;
- confirm switching to the parameter edit mode (Figure 14).

ENTER button – select the parameter to be configured.

The menu options of the SETUP mode, their parameters (in the metric system of units) and functions are listed in the Table 4

Table 4

| Menu option (parameter) | Parameter value | Description |
|---|-------------------------------------|---|
| Mode | Time / Velocity / Crack / Front | Selects the measurement mode |
| Accumulation, Qty | 1 / 2 / 4 / 8 / 16 / 32 / 64 | Sets quantity of accumulations |
| AGC | On / Off | Switches On/Off the automatic control system of the receive path gain |
| Gain, dB (only for AGC Off) | from 40 to 80 in increments of 2 | Sets the gain |
| Frequency, Hz | from 2 to 25 | Repetition frequency of the sounding pulses |
| Norm, μ s (in the FRONT mode only) | from 0.1 to 20.0 | Sets the normative value of duration of the rising edge (front) of the signal |
| Clear memory, % | Occupied memory volume in % | Starts the memory cleaning procedure |
| Calibration | – | Starts the calibration procedures |
| Delay, μ s | from 0 to 20 | Instrument-specific parameter associated with constructive features |
| Base, mm | from 149 to 151 | Actual value of the instrument's scanning base |
| Sound | On / Off | Monitoring the sound indication |
| Vibration | On / Off | Monitoring the vibration indication |
| Language | Russian / English | Selects the interface language |
| Measuring units | mm / inches | Selects the measurement unit system |
| Brightness, % | from 10 to 100 | Sets the display brightness |
| Current time | Editable | Sets date and time |

2

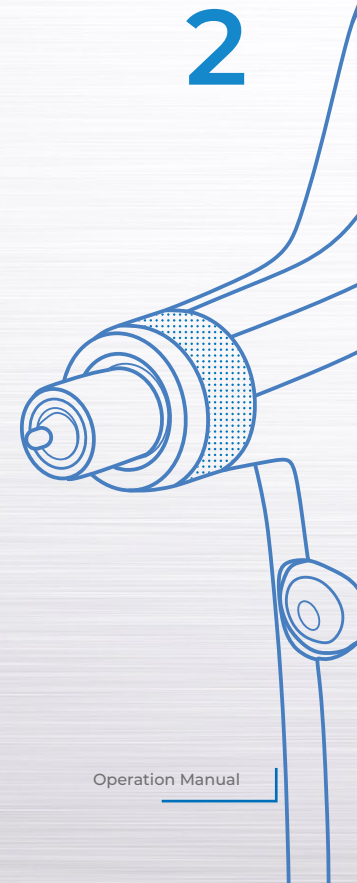

2

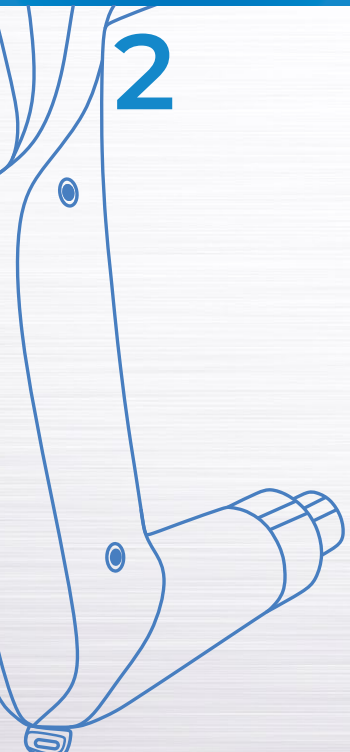

2.3.1.1 MODE OPTION

Select the measurement mode:

- TIME – measurement of propagation time of ultrasonic waves in the material;
- VELOCITY– measurement of propagation velocity of ultrasonic waves in the material;
- CRACK – evaluation of the depth of the crack facing the surface;
- FRONT – measurement of the time interval from the moment when the signal exceeds the threshold value for the first time (threshold value is set automatically by the noise peaks) to the time when the first half-wave of the signal reaches the maximum value.

ENTER button sequential switching between the modes.

The MODE option screen is shown in the Figure 15.

2.3.1.2 ACCUMULATION Option

Setting the quantity of accumulations.

The permissible value range is 1, 2, 4, 8, 16, 32, 64.

The screen for the ACCUMULATION option is shown in the Figure 16.

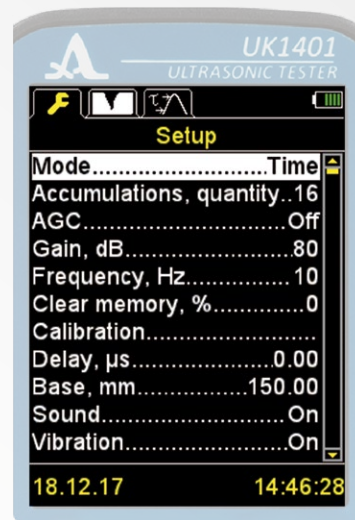

Figure 15

2

2.3.1.3 AGC Option

Switching On/Off the automatic control system of the receive path gain.

The permissible value range is On / Off.

The screen for the AGC option is shown in the Figure 17.

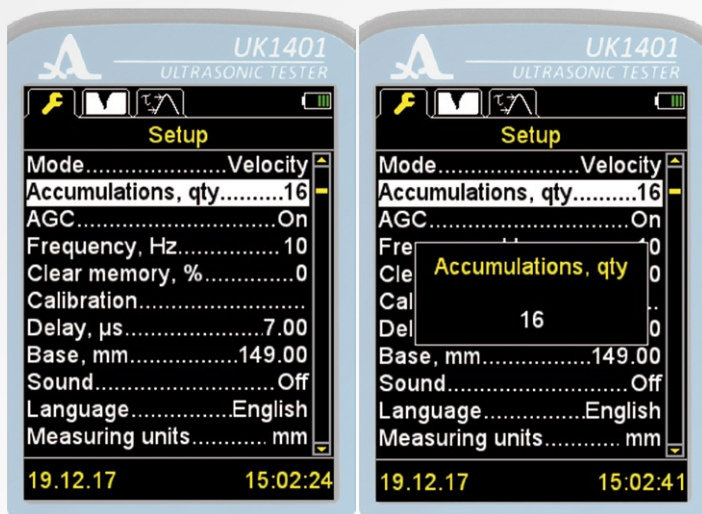

Figure 16

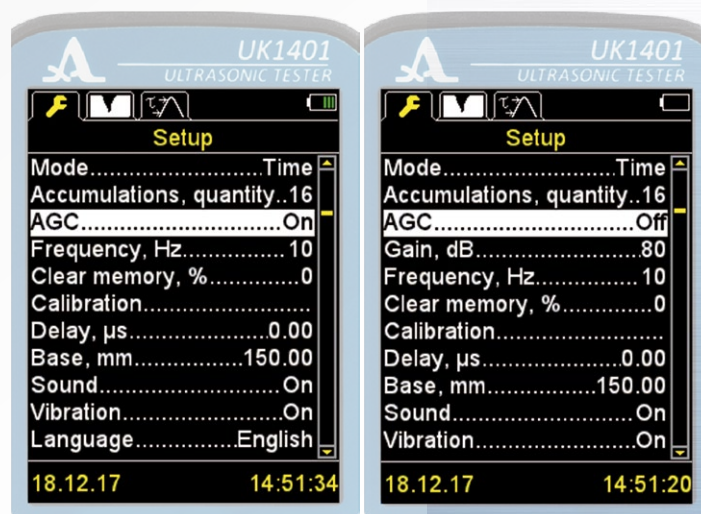

Figure 17

2

2.3.1.4 GAIN Option (only if AGC – OFF)

Setting the signal gain. The permissible value range is from 40 to 80 dB.

The screen for the GAIN option is shown in the Figure 18

2.3.1.5 FREQUENCY Option

Setting the repetition frequency of the sounding pulses. The permissible value range is from 2 to 25 Hz.

The screen for the FREQUENCY option is shown in the Figure 19

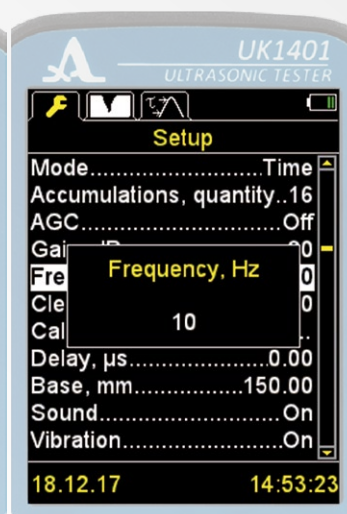
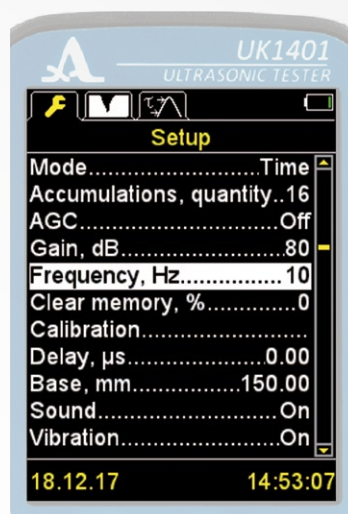
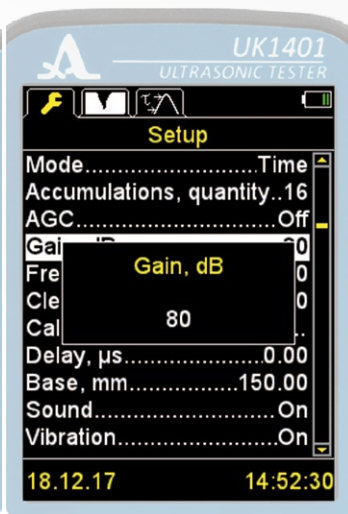
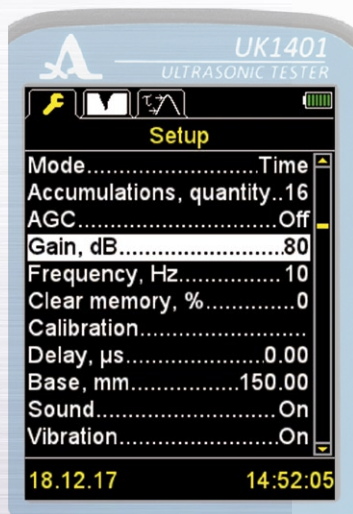

Figure 18

Figure 19

To increase the testing quality, try to select the highest possible value of the repetition frequency of the sounding pulses. However, when inspecting the small items (not exceeding several dozen centimeters) with low attenuation, the ultrasonic vibrations in the material will not have time to fade completely by the time when the next sounding signal will be sent to the material, thus it can result in false readings. In that case, the repetition frequency of the sounding pulses should be decreased, if required, to the minimum value.

2.3.1.6 NORM Option (in the FRONT mode only)

Setting of the rated value duration of the rising edge (front) of the signal.

The permissible value range is from 0.1 to 20.0 μs .

The screen for the NORM option is shown in the Figure 20.

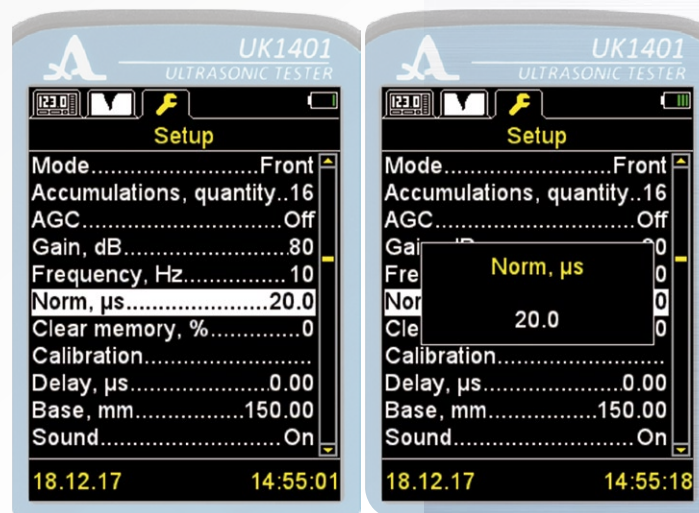

Figure 20

2

2.3.1.7 CLEAR MEMORY Option

Deletion of the measurement results from the memory.

The parameter indicates the filling percentage of the memory with the measurement results.

The screen for the CLEAR MEMORY option is shown in the Figure 21.

After the memory cleaning is started, the “Saved data will be deleted. Continue?” message will be displayed (Figure 22).

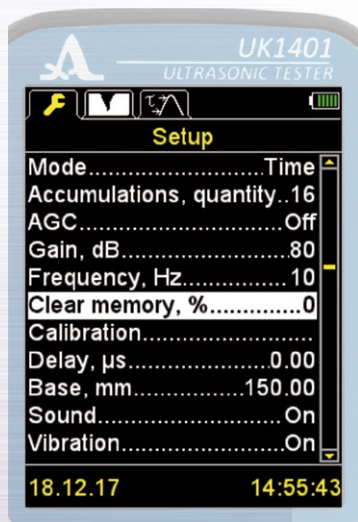

Figure 21

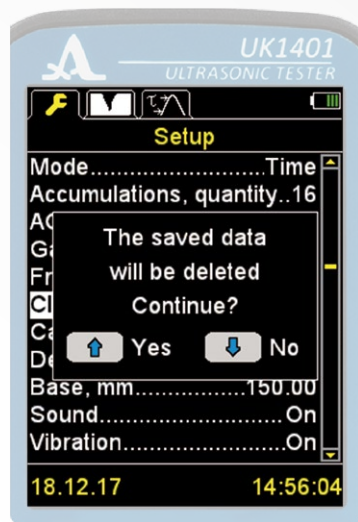

Figure 22

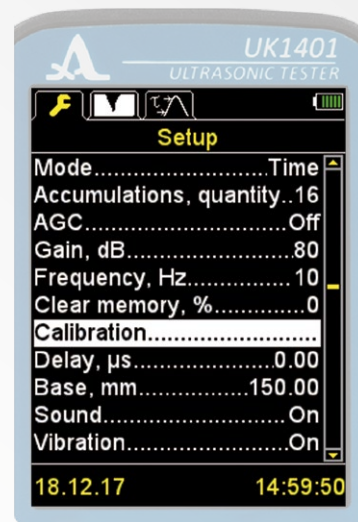

Figure 23

2.3.1.8 CALIBRATION Option

The CALIBRATION option is used for the initial calibration of the instrument.

The screen for the CALIBRATION option is shown in the Figure 24.

To start the calibration, press the "ENTER" button and follow the instructions on the instrument screen (Figure 24).

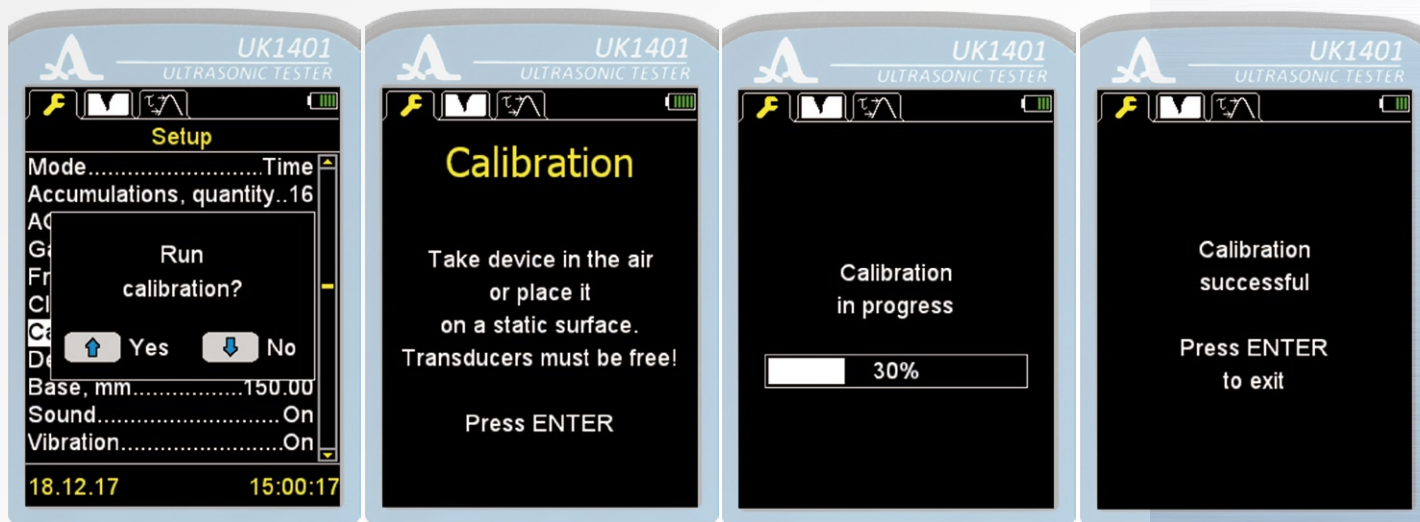

Figure 24

2

2.3.1.9 DELAY Option

The DELAY option is used for setting the hardware time delay.
The permissible range of the delay values is from 0 to 20 μ s.
The screen for the DELAY option is shown in the Figure 25



Figure 25

2.3.1.10 BASE Option

The BASE option is used for setting the actual value of the base.
The permissible value range is from 149 to 151 mm.
The screen for the BASE option is shown in the Figure 26.

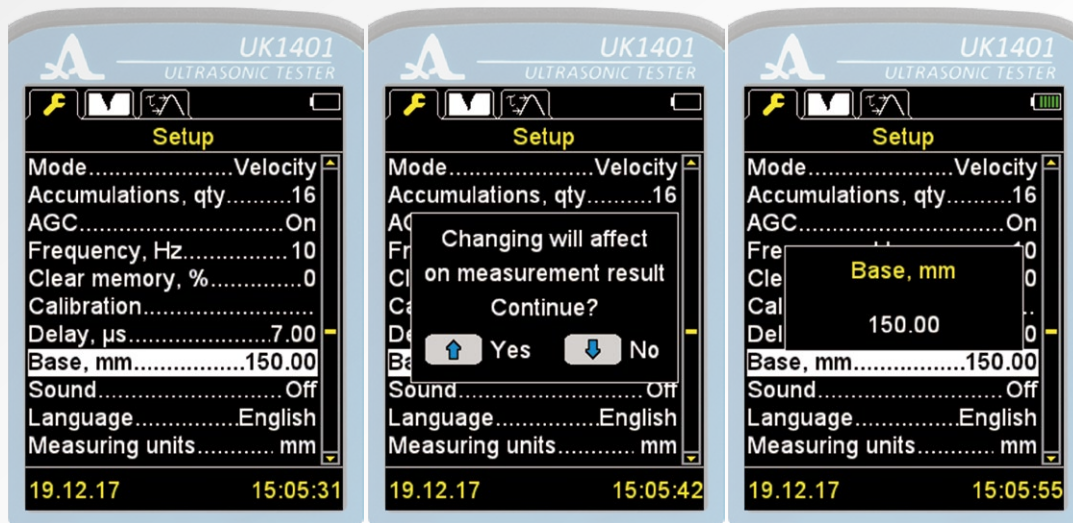
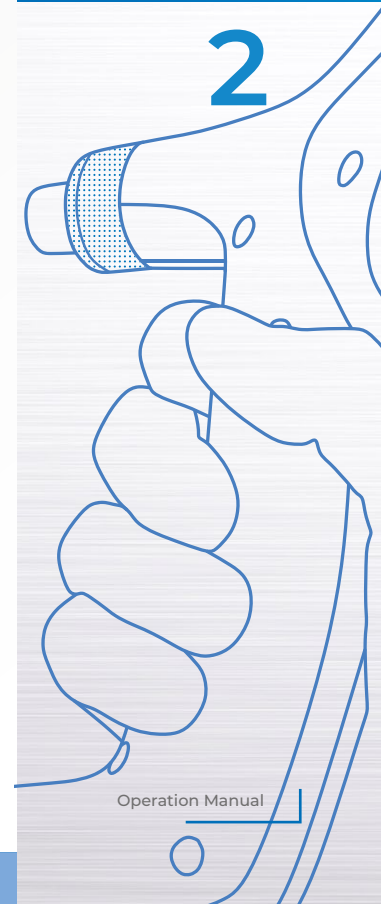

Figure 26



2.3.1.11 SOUND Option

Switching ON/OFF the sound of the instrument.

To improve the usability of the instrument, the main events occurring during measurements, adjustments, and when the keys are pressed, are accompanied by sounds.

As well, the sound indication is used for acoustic monitoring of the ultrasonic signals reception. The acoustic signals inform the operator about the processes, and do not affect the measurement results at that.

The screen for the SOUND option is shown in the Figure 27.

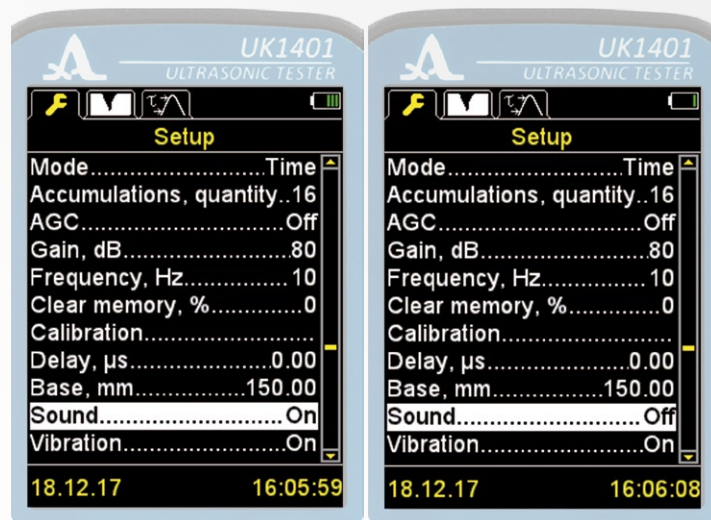
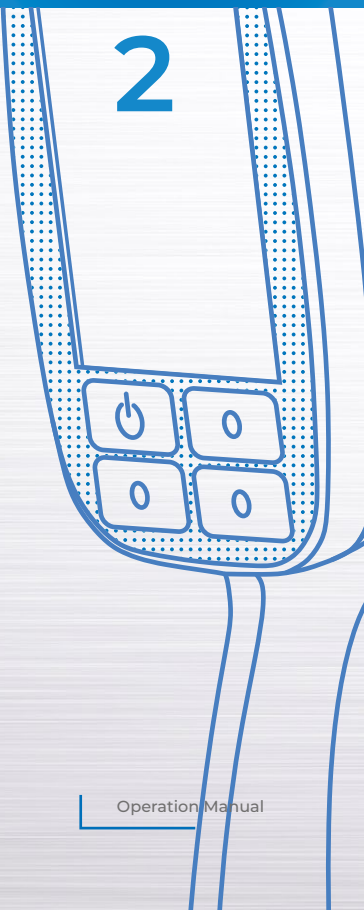

Figure 27

2.3.1.12 LANGUAGE Option

Select the interface language of the instrument:

- Russian;
- English;

The screen for the LANGUAGE option is shown in the Figure 28.

2.3.1.13 MEASURING UNITS Option

Selecting the measurement units of the system:mm / inches. The screen for the MEASURING UNITS option is shown in the Figure 29.

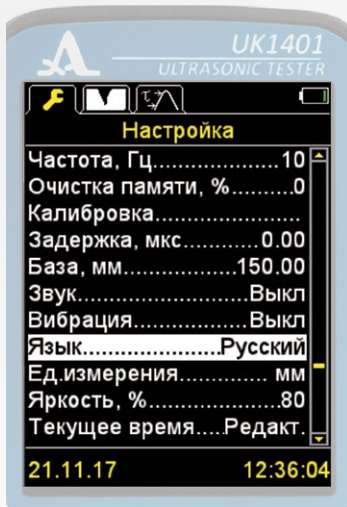

Figure 28

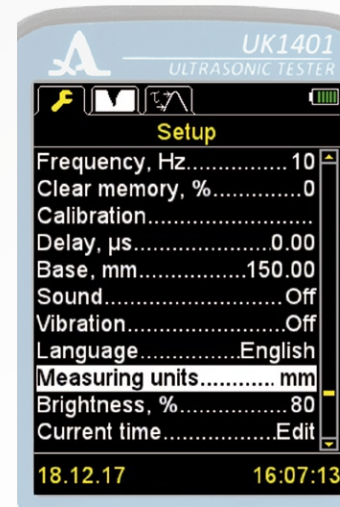
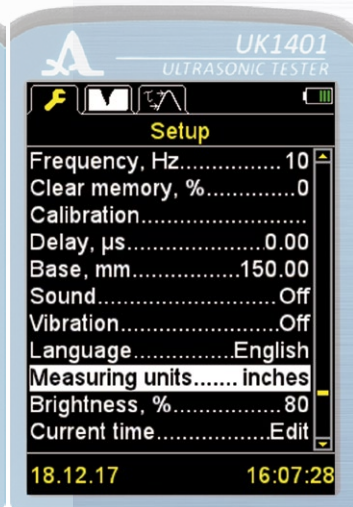

Figure 29



2

2.3.1.14 BRIGHTNESS Option

The value setting range of display brightness is from 10 to 100 %.
The screen for the BRIGHTNESS option is shown in the Figure 30.

2.3.1.15 CURRENT TIME Option

Setting date and time. The screen for the CURRENT TIME option is shown in the Figure 31.

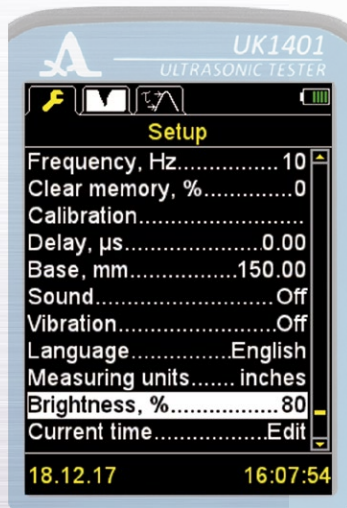

Figure 30

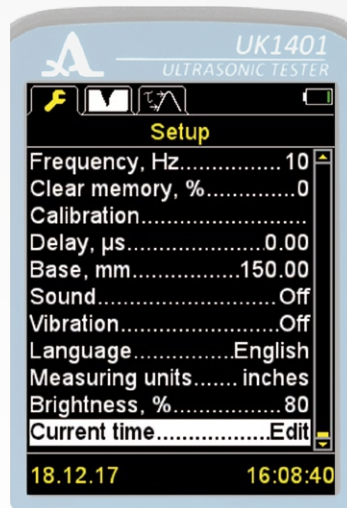
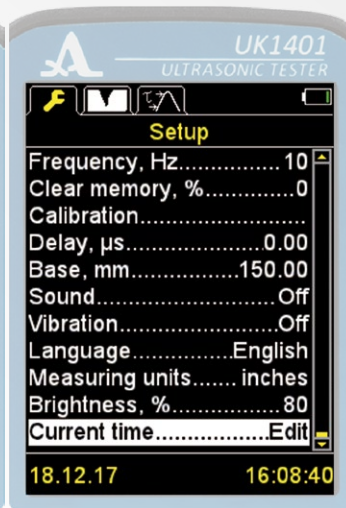

Figure 31



2.3.2 TIME / VELOCITY Modes

2

In the TIME / VELOCITY modes the screen is divided into two areas: the upper one displays the information on measurement, the lower displays the information on the results already recorded in the TIME / VELOCITY modes (groups, group cells and measurement results in μs or m/s depending on the selected operation mode) (Figure 32).

Place the instrument on the inspected object with both ultrasonic transducers, trying to position it so that the transducers are perpendicular to the surface of the object. Immediately after the transducers touch the surface of the object being inspected, the instrument switches from the standby mode (seldom sending of the sounding pulses) into the active state (often sending of the sounding pulses).



If the sound indication is On, the measurements are accompanied by short sound signals. If sound signals are missing, it indicates that the instrument is not in the active state. I.e. either the ultrasonic velocity in the material of the inspected object is below the minimum permissible value, or there is a crack in the area between the transducers that prevent the ultrasonic signal from passing to the receiving transducer.



After the measurements are completed and the instrument is removed from the inspected object, the measurement result will remain on the screen for 10 to 15 seconds, after that it will change into horizontal strokes.

While measuring try to hold the instrument motionless if possible.

If the measurement results in the same place of inspection substantially differ, decrease the repetition frequency of the sounding pulses. To do that, select the FREQUENCY option in the SETUP mode and decrease its value. Repeat the measurements in the same place of the inspected object.

Active keys:

  – holding – navigating the columns of the group – CELL – RESULT in corresponding direction;

  – short pressing – navigating the lines of the active column in corresponding direction.

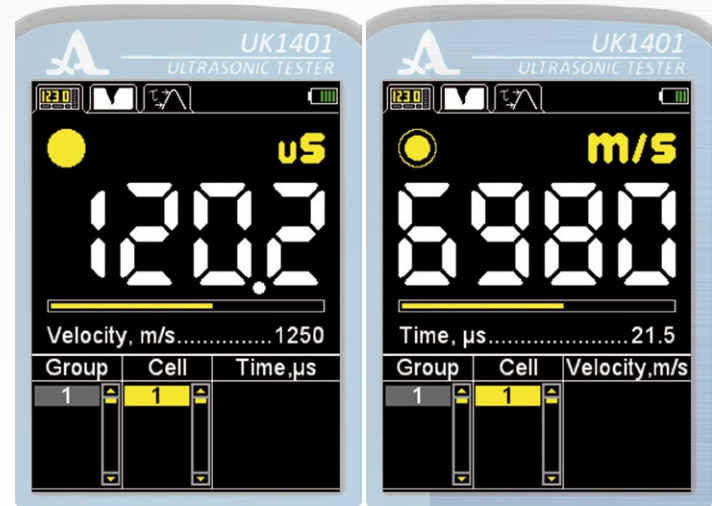



Figure 32

2



2.3.2.1 Add new last group

Use the  key to switch to the last group. The user will be prompted to add a new group. If the group is not empty, then the group will be added under the next serial number. If the last group is empty, then the user will be informed and no group will be added (Figure 33).

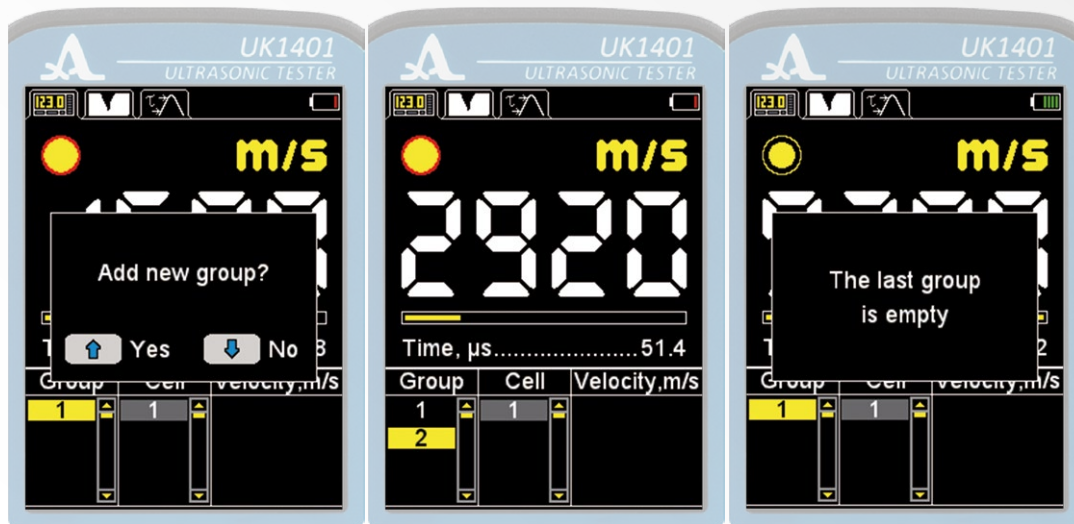

Figure 33

2.3.2.2 RECORDING the Result

The measurement results are stored in the cells of the memory. The cells form groups. The groups and the cells in the groups are identified by the serial numbers. The numbering of the groups and the cells in each group is started with "1".

The maximum quantity of the cells in a group is 500.

The maximum quantity of all groups is 100.

When the quantity of the cells in a group becomes maximum, a corresponding message is indicated on the display.

In practice, it is more convenient to record the results into small groups (by several dozen values). You can return to any existing group if required and continue recording the results in it.

To record a result, select any existing group or create a new one prior to measurements, and press the ENTER button. The measurement result will be saved in the last cell of the current group.

2.3.2.3 Viewing and adjusting the measurement results

The user can view any result recorded in the memory. The result can be measured again in the same point and overwritten if the user doubts its reliability.

To see the results, switch to the CELL column. The ❄ character will be displayed on the screen (Figure 34).

Scrolling along the measurement results is performed successively by the cells of the groups according to the selected view direction. When the first/last cell in the group is reached, the program will switch to the next/previous group of the results correspondingly.

To correct a result, please perform the following:

- using the keys switch to the cell with the recorded result which will be corrected;
- while pressing and holding the  key, switch to the RESULT column, at that the ❄ sign will disappear.

Note: Actually, the result will remain in the memory up to the moment it will be recorded to the selected cell of new purpose. To return to the view mode not changing the result in the cell, press the  key.

- perform the measurement. If the measurement result is satisfactory, then press the "ENTER" button to record it into the selected cell. The instrument will automatically return to the view mode after doing it.

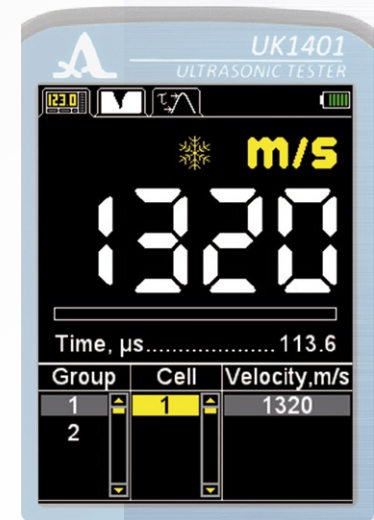

Figure 34

2



2.3.3 CRACK mode

The screen in the measurement mode of the crack depth is shown in the Figure 35.

In the lower part of the screen the intervals of the ultrasound propagation time are displayed if there is a crack crossing the propagation path of the signal between the ultrasonic transducers to the right, and to the left if there is no crack in the material.

The mode allows for the determination of the depth of the crack facing the surface. To do it, measure the ultrasound propagation time through the solid material near the crack, and then measure the signal propagation time through the crack. The instrument will calculate and display the value of the crack depth on the screen.

The instrument determines the DC crack depth (Figure 36) comparing the propagation time t_0 of the ultrasonic waves in the area without crack (path ADB) and t in the area with a crack (path ACB) using the formula:

$$DC = \frac{AB}{2} \cdot \sqrt{\frac{t^2}{t_0^2} - 1},$$

where: AB – distance (base of the instrument) between the transmitting transducer and the receiving transducer.



Figure 35

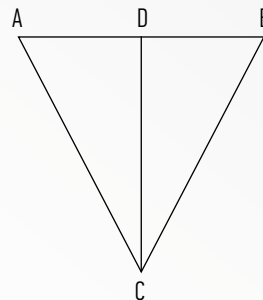

Figure 36

2

To measure the crack depth, please perform the following:

- Press the instrument for 15 to 20 seconds onto the surface of the object being inspected parallel to the crack about 20 to 30 mm apart.
 - The instrument will measure the ultrasonic sound propagation time on the monolithic section of the inspected object "without crack".
 - Press the "ENTER" button to record it.
 - Place the transmitting and receiving transducers in such a manner that the crack is between them. To decrease an error, the crack must be possibly located at even distance to each transducer, and must be located perpendicular to lines of their placement.
 - The measured value of the crack depth will be displayed on the screen.
- If depth value of another crack shall be determined on the same object, then place the tester over another crack, etc.

Note: Do not press the "ENTER" button after the measurement of time over the crack, since in that case the instrument will take the measured time value as a basic one.

2.3.4 FRONT mode

The mode allows for detection of front duration (time) of the first half wave (arrivals) of the ultrasonic signal from zero to the peak level; it allows for the quality evaluation of the concrete structure. In particular, the mode is used to monitor the supports of the railway contact network.

The screen in the measurement mode of the crack depth, within the set standard (green scale) and exceeding the set standard (red scale) is shown in the Figure 37.

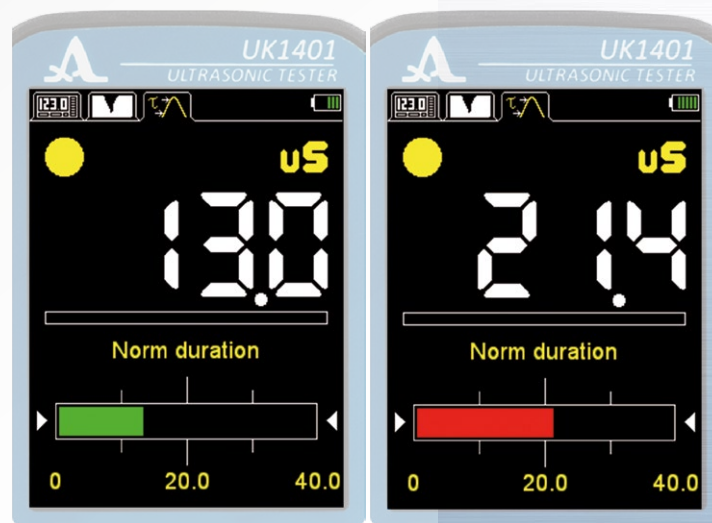
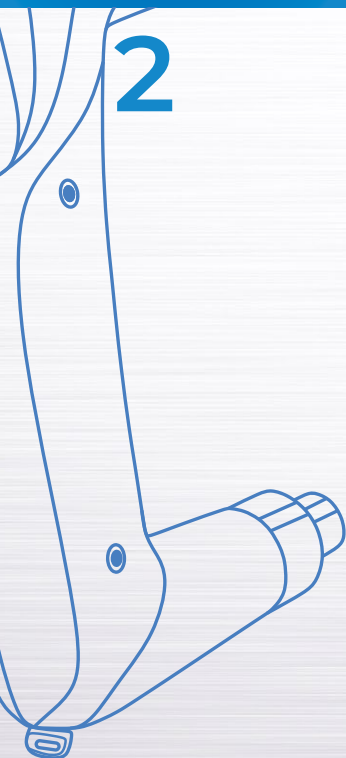

Figure 37

2



Select an area without visible defects (cracks, grooves, air pockets, etc.) on the surface of the object to be inspected. The length of the area around the circle perimeter must be at least 180 mm, and height along the moving line must be at least 250 to 400 mm.

To measure the duration of the rising edge (front) of the signal, please perform the following:

- Press the instrument to the surface of the inspected object perpendicular to the main reinforcement and wait for 15-20 s.
- Remove the instrument from the inspected object. The measurement results will remain on the screen.
- Move the instrument in parallel up or down at a distance of 100 150 mm, and measure the second time.
- In the same manner, perform the third measurement, the duration of the third measurement shall be equal to the first wavefront.
- Determine the average value of three measurement results.
- Compare the received value to the rated value specified in the settings (for sound concrete with strength value specified by the project documentation, without significant structural damage).

If the received average measurement value of duration of the first front of the wave exceeds the above-named criterion value, then there is evidence of micro cracks presence and decreased concrete strength.

2.4 TRANSFER DATA TO PC

To transfer the data from the instrument to PC, please perform the following: connect the instrument to PC via the USB A – Micro B cable included in the delivery kit.

The OS will detect the instrument as an external removable disk named ACSYS DISC openable in the MS Windows “Explorer” or any File Explorer.

The data can be read directly from the instrument, as well as copied to PC.

You can name the data file as required for copying.

Digital data are saved in the memory of the instrument in the CSV format (CommaSeparatedValues) convenient for export. Further, the measurement results can be analyzed and processed by means of external programs (Figure 38). The data will be saved in a single file named RESULTS.CSV. The results will be arranged in the file according to the number of the group.

Working with numerical data by means of external programs

Working with "MS Excel"

| | A | B | C | D | E | F |
|----|-------|------|----------|---------------|-------------------|-------------------|
| 1 | Group | Cell | Time, us | Velocity, m/s | Date of measuring | Time of measuring |
| 2 | 1 | 1 | 54,4 | 2760 | 29.11.2017 | 14:18:28 |
| 3 | 1 | 2 | 54,7 | 2740 | 29.11.2017 | 14:18:31 |
| 4 | 1 | 3 | 54,4 | 2760 | 29.11.2017 | 14:18:33 |
| 5 | 2 | 1 | 51,9 | 2890 | 29.11.2017 | 14:19:12 |
| 6 | 2 | 2 | 51,8 | 2890 | 29.11.2017 | 14:19:15 |
| 7 | 2 | 3 | 51,8 | 2900 | 29.11.2017 | 14:19:18 |
| 8 | 3 | 1 | 43,9 | 3410 | 29.11.2017 | 14:19:34 |
| 9 | 3 | 2 | 43,9 | 3420 | 29.11.2017 | 14:19:37 |
| 10 | 3 | 3 | 52,5 | 2860 | 15.12.2017 | 11:36:27 |

Working with a "Notepad"

```

RESULTS — Блокнот
Файл  Правка  Формат  Вид  Справка
Group;Cell;Time, us;Velocity, m/s;Date of measuring;Time of measuring
1;1;54,4;2760;29.11.2017;14:18:28
1;2;54,7;2740;29.11.2017;14:18:31
1;3;54,4;2760;29.11.2017;14:18:33
2;1;51,9;2890;29.11.2017;14:19:12
2;2;51,8;2890;29.11.2017;14:19:15
2;3;51,8;2900;29.11.2017;14:19:18
3;1;43,9;3410;29.11.2017;14:19:34
3;2;43,9;3420;29.11.2017;14:19:37
3;3;52,5;2860;15.12.2017;11:36:27
  
```

2





3

MAINTENANCE

The maintenance of the instrument includes cleaning the electronic unit from dirt and dust, and charging the battery.

3.1 ACCUMULATOR

The rechargeable battery is designed to be operated within a broad temperature range. At negative temperatures the battery capacity is reduced. At low temperatures the capacity is 15% below the capacity at normal temperatures.

The instrument will automatically switch off when the battery is completely discharged.

The accumulator is equipped with built-in battery overcharge protection, over discharge, over current and over temperature.

The battery service life is designed for the guaranteed service life of the instrument.

The battery shall be replaced by service centers only.

ATTENTION: THE INSTRUMENT WARRANTY WILL BE VOIDED, IF THE USER REPLACES THE BATTERY INDEPENDENTLY!

3.2 CHARGING THE ACCUMULATOR

The battery shall be charged via the external charger or PC.

The charging time depends on the depletion of the accumulator. The total charge time is 4 to 5 hours. Multi-recharging is allowed.

The instrument can be operated during battery charging, though the charging time will increase to 2 to 3 times.

ATTENTION: NEVER STORE THE INSTRUMENT WITH THE DISCHARGED BATTERY TO PREVENT ITS FAILURE!

3.3 TROUBLESHOOTING

Contact the representatives of the manufacturer if you have questions about operation of the instrument to get assistance and consult the experts.

4

STORAGE

The instrument should be shelf stored in the hard case included in the delivery kit. The storage conditions shall correspond to GOST 15150-69 (placement category 1).

The arrangement of the instruments in warehouses shall enable their free movement by the personnel and unrestricted access to them.

The distance between the instruments and the walls, floor of the warehouse and other instruments in the warehouse shall be at least 100 mm.

The distance between the heating units in the warehouse and the instruments shall be at least 0.5 m.

The storage room shall be free from the current-conducting dust, admixtures of aggressive gases and corrosive vapors able to attack the instruments.



5

TRANSPOR- TATION

The instrument shall be transported in the hard case included in the delivery kit.
The transportation conditions with regard to the impact of the external environmental factors should correspond to the storage conditions (placement category 5) according to GOST 15150-69.

The packaged instruments can be transported in any vehicles to any distances without speed limits.

The packaged instruments should be properly and steadily fixed to prevent shocks of devices against each and against vehicle walls during the transportation. When transported in open vehicles the instruments shall be protected against rain and water splashes.

The terms and conditions of transportation must comply with requirements of technical standards and code of practice applicable for a given means of transport individually.

If shipped by air, properly packed instruments should be placed in hermetically sealed and heated compartments.

In case the transportation conditions differ from the operation conditions, the instruments shall be kept under normal environmental conditions for at least 2 hours prior to operation.

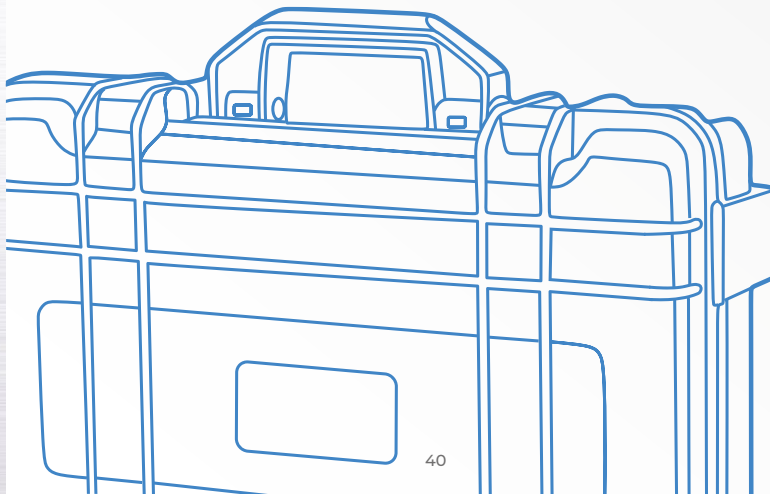



NOTES



NOTES

A large rectangular area with horizontal dashed lines, intended for handwritten notes.



ULTRASONIC TESTER

UK1401



OPERATION MANUAL

Revision: February 2018